

$\phi 2\frac{3}{16}$  inch [ $\phi 55.563$ ]

$\phi 120$

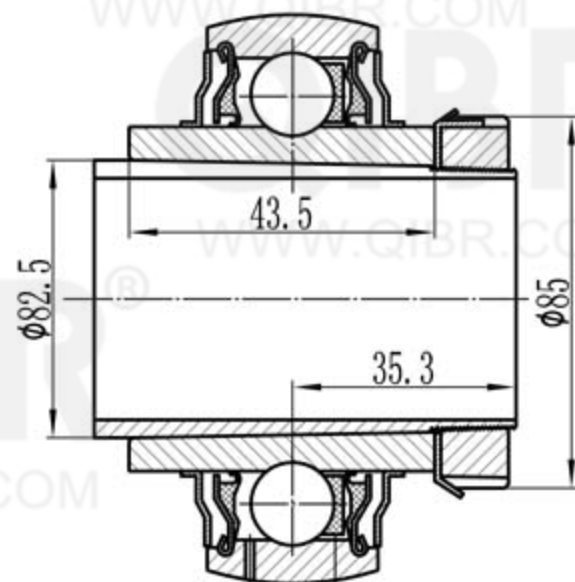
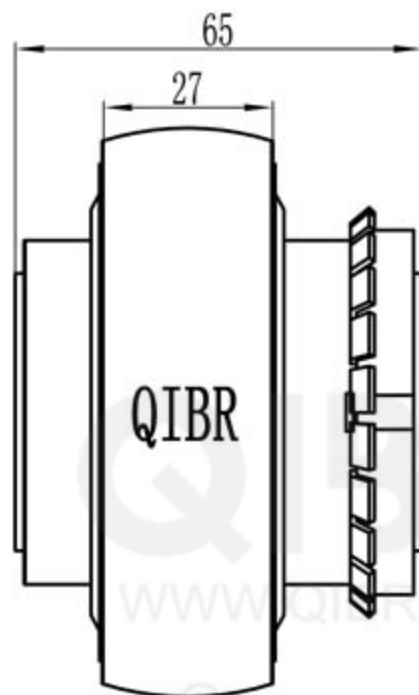
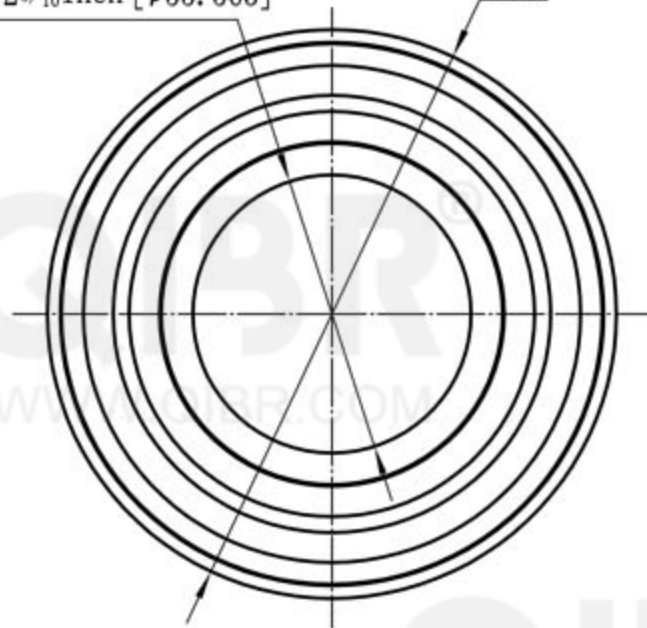

**QIBR**<sup>®</sup>  
BEARINGS

LUOYANG QIBR BEARING CO., LTD

<http://www.QIBR.com>

INSERT BALL  
BEARING

PART NUMBER  
QYSA 213-2FK/HA2313