

$\phi 1 \frac{3}{4}$ inch [$\phi 44.45$]

$\phi 90$

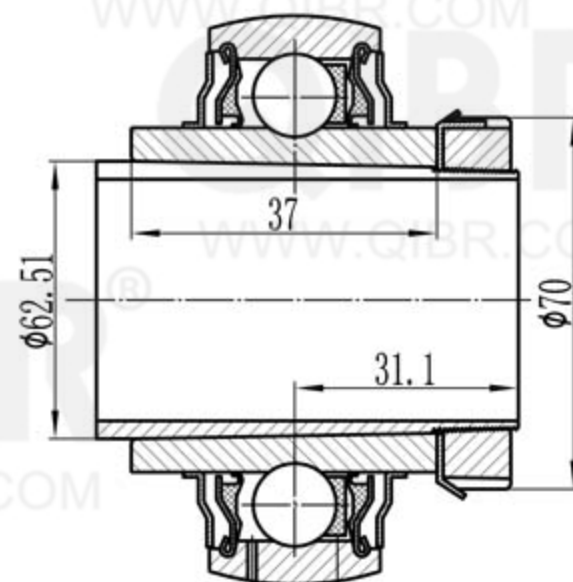
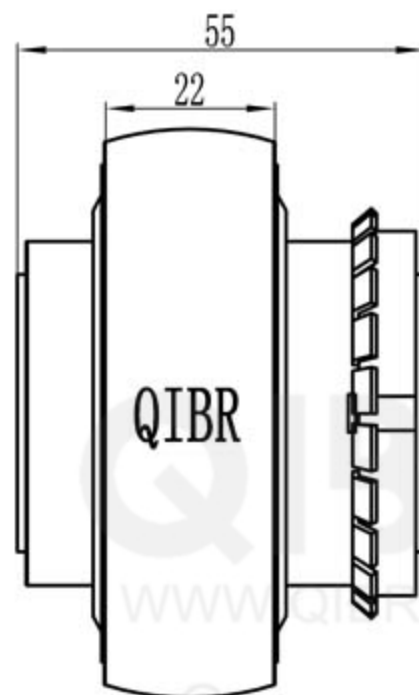
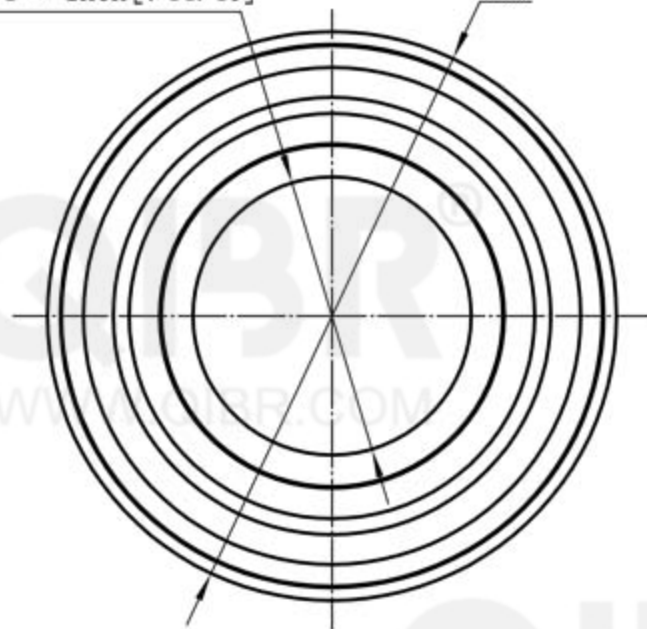

QIBR[®]
BEARINGS

LUOYANG QIBR BEARING CO., LTD

<http://www.QIBR.com>

INSERT BALL
BEARING

PART NUMBER
QYSA 210-2FK/HE2310