

$\phi 1\frac{1}{4}$ inch [$\phi 31.75$]

$\phi 80$

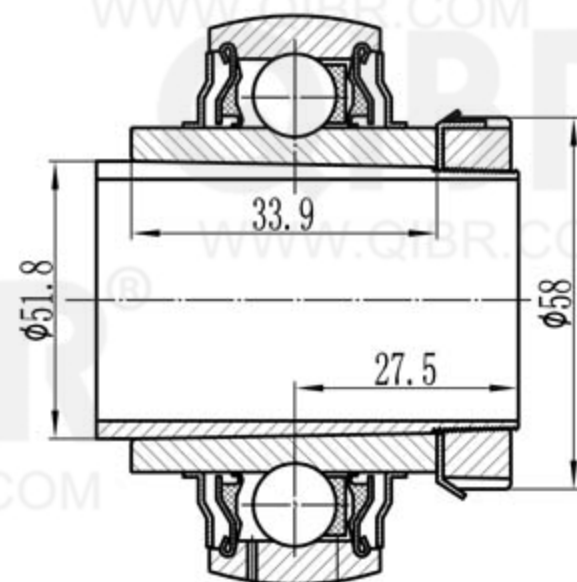
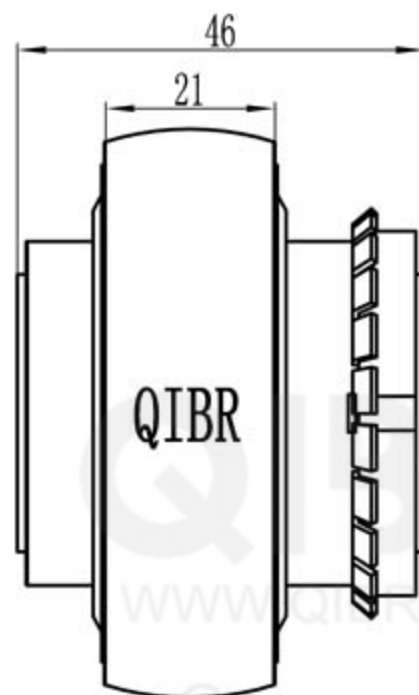
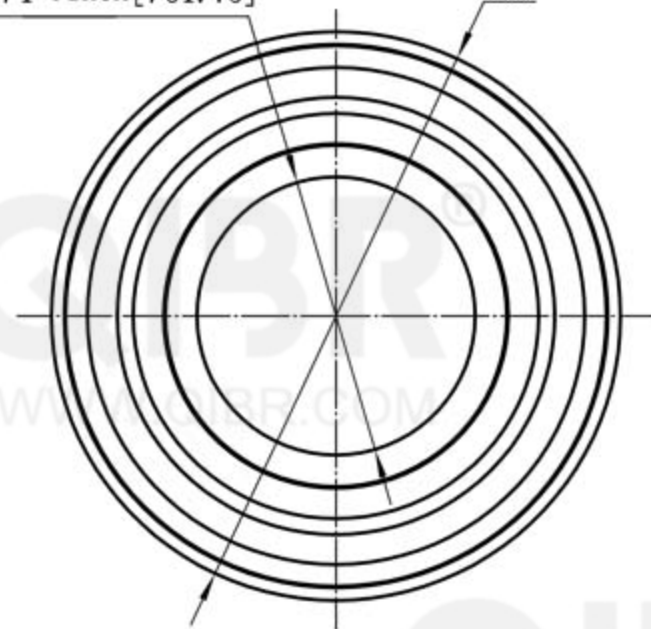

QIBR[®]
BEARINGS

LUOYANG QIBR BEARING CO., LTD
<http://www.QIBR.com>

INSERT BALL
BEARING

PART NUMBER
QYSA 208-2FK/HE2308