

$\phi 2\frac{3}{16}$ inch [$\phi 55.563$]

$\phi 110$

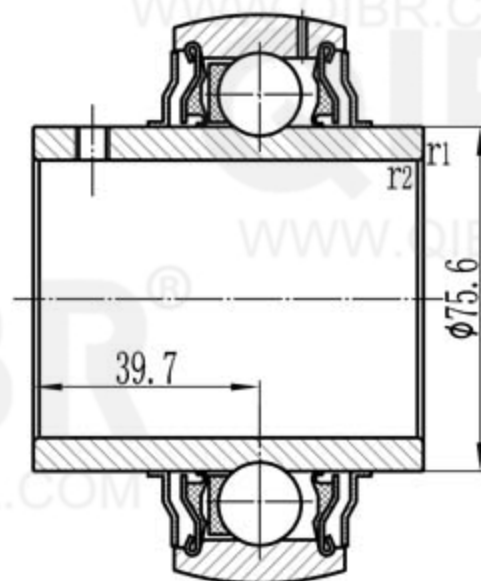
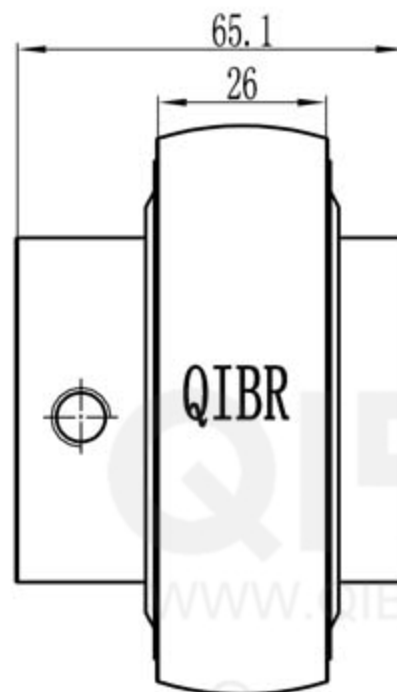
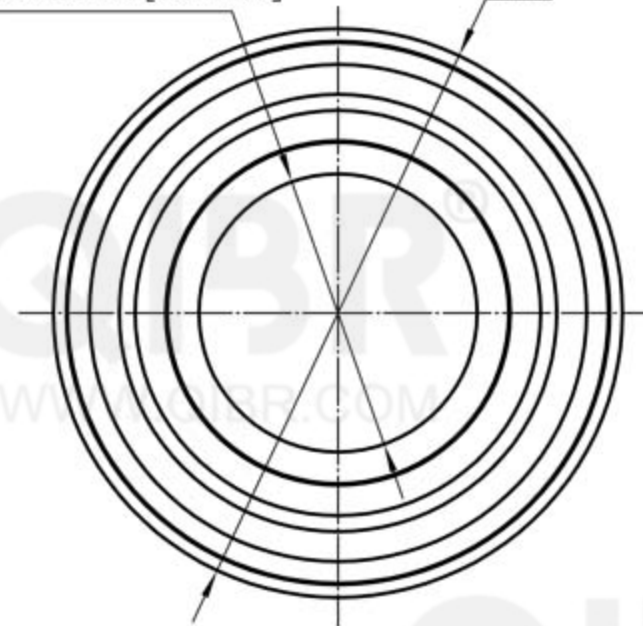

QIBR[®]
BEARINGS

LUOYANG QIBR BEARING CO., LTD

<http://www.QIBR.com>

INSERT BALL
BEARING

PART
NUMBER QYAR 212-203-2F