

$\phi 1\frac{15}{16}$ inch [$\phi 49.213$]

$\phi 90$

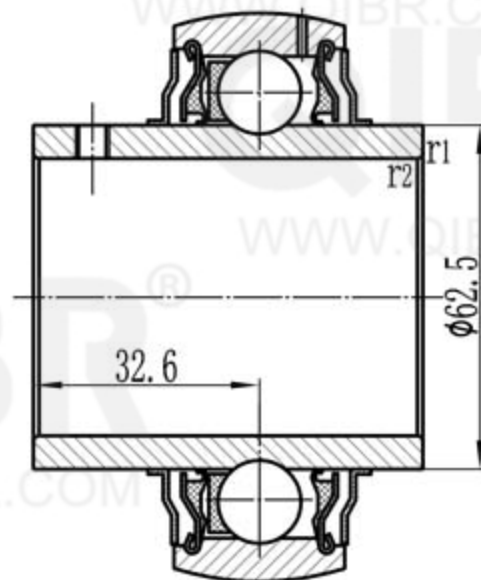
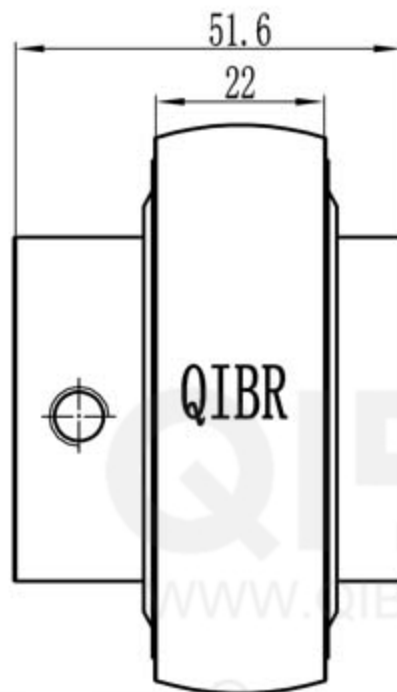
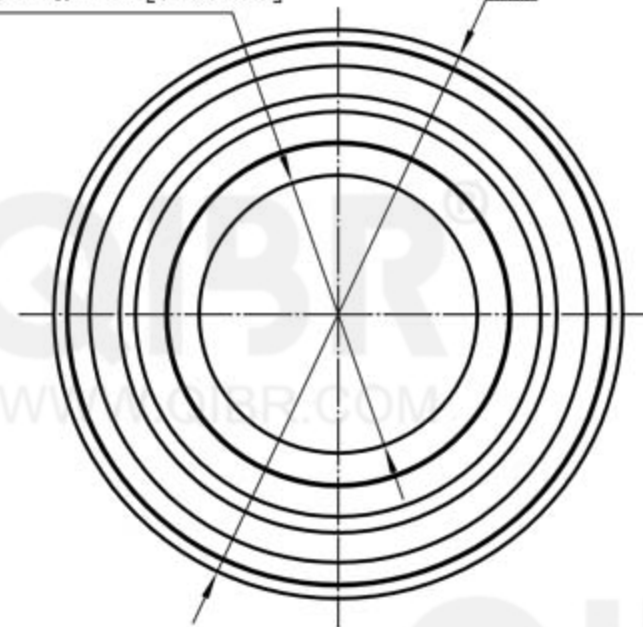

QIBR[®]
BEARINGS

LUOYANG QIBR BEARING CO., LTD

<http://www.QIBR.com>

INSERT BALL
BEARING

PART
NUMBER QYAR 210-115-2F