

$\phi 1\frac{7}{16}$ inch [$\phi 36.513$]

$\phi 72$

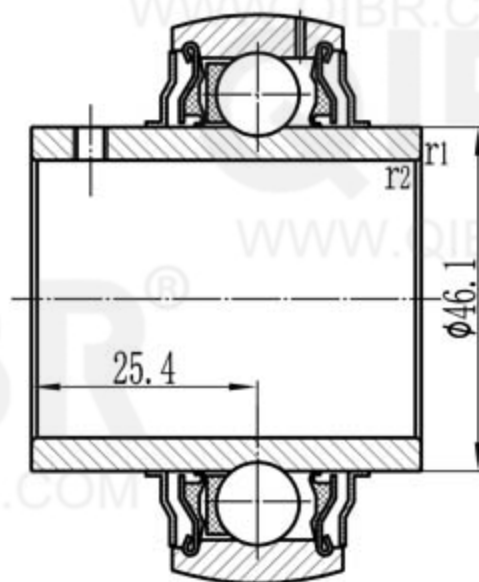
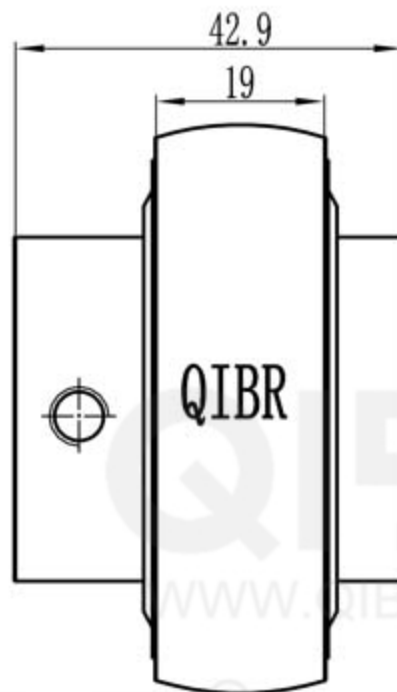
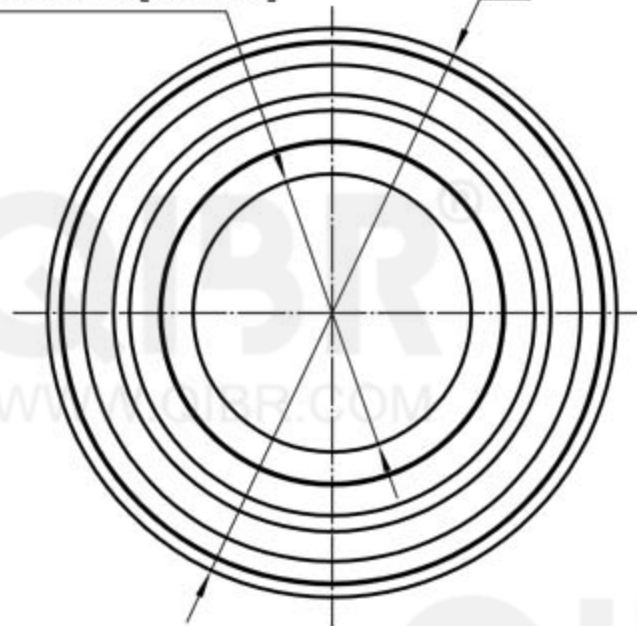

QIBR[®]
BEARINGS

LUOYANG QIBR BEARING CO., LTD

<http://www.QIBR.com>

INSERT BALL
BEARING

PART
NUMBER QYAR 207-107-2F