

$\phi 1\frac{1}{8}$ inch [ $\phi 28.575$ ]

$\phi 62$

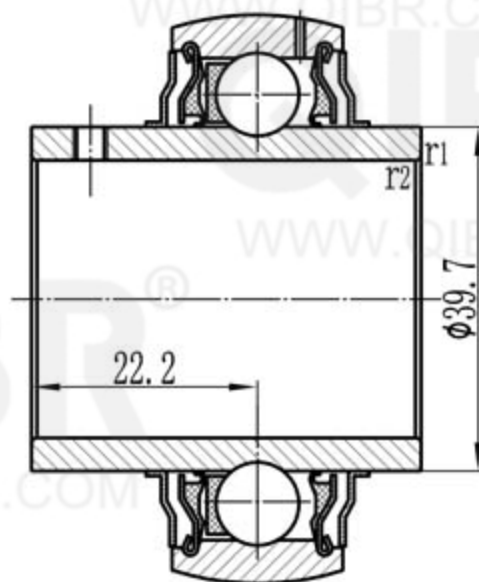
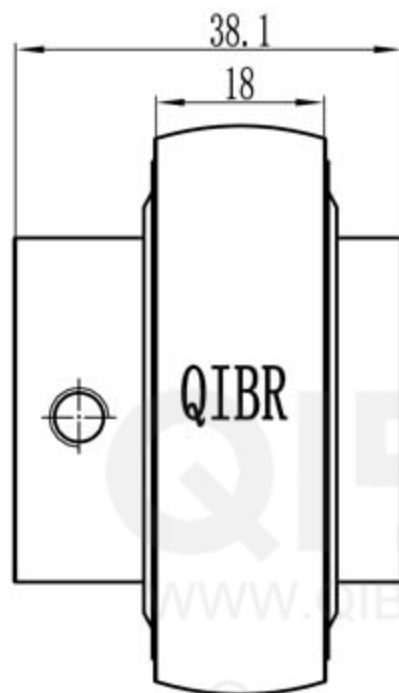
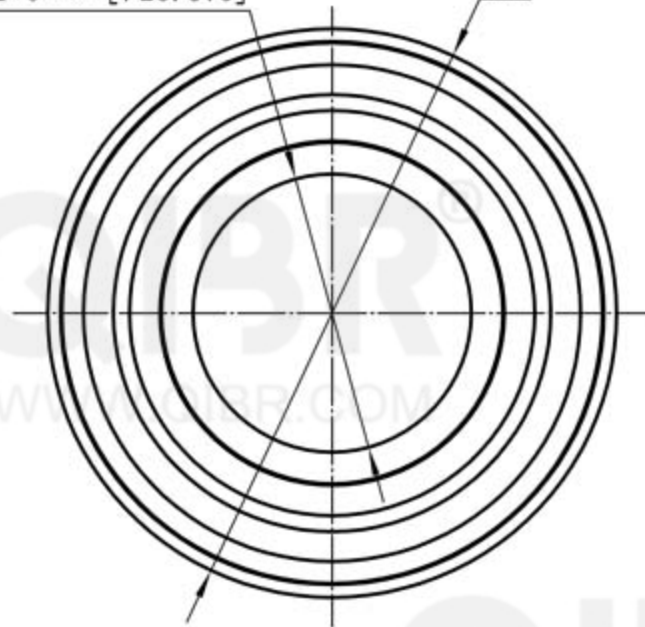

**QIBR**<sup>®</sup>  
BEARINGS

LUOYANG QIBR BEARING CO., LTD

<http://www.QIBR.com>

INSERT BALL  
BEARING

PART  
NUMBER QYAR 206-102-2F