

0.3125inch $\begin{matrix} +0.000 \\ -0.005 \end{matrix}$

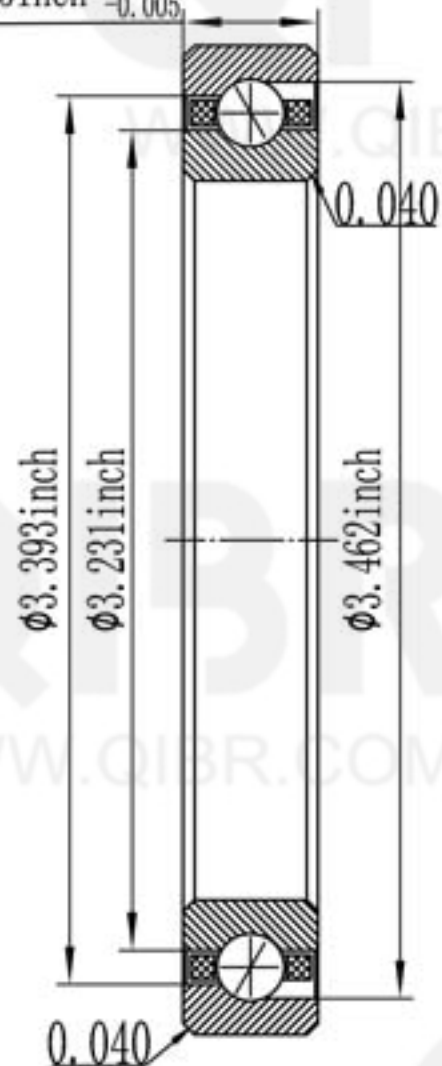

ϕ 3.6252inch $\begin{matrix} 0.0000 \\ -0.0008 \end{matrix}$

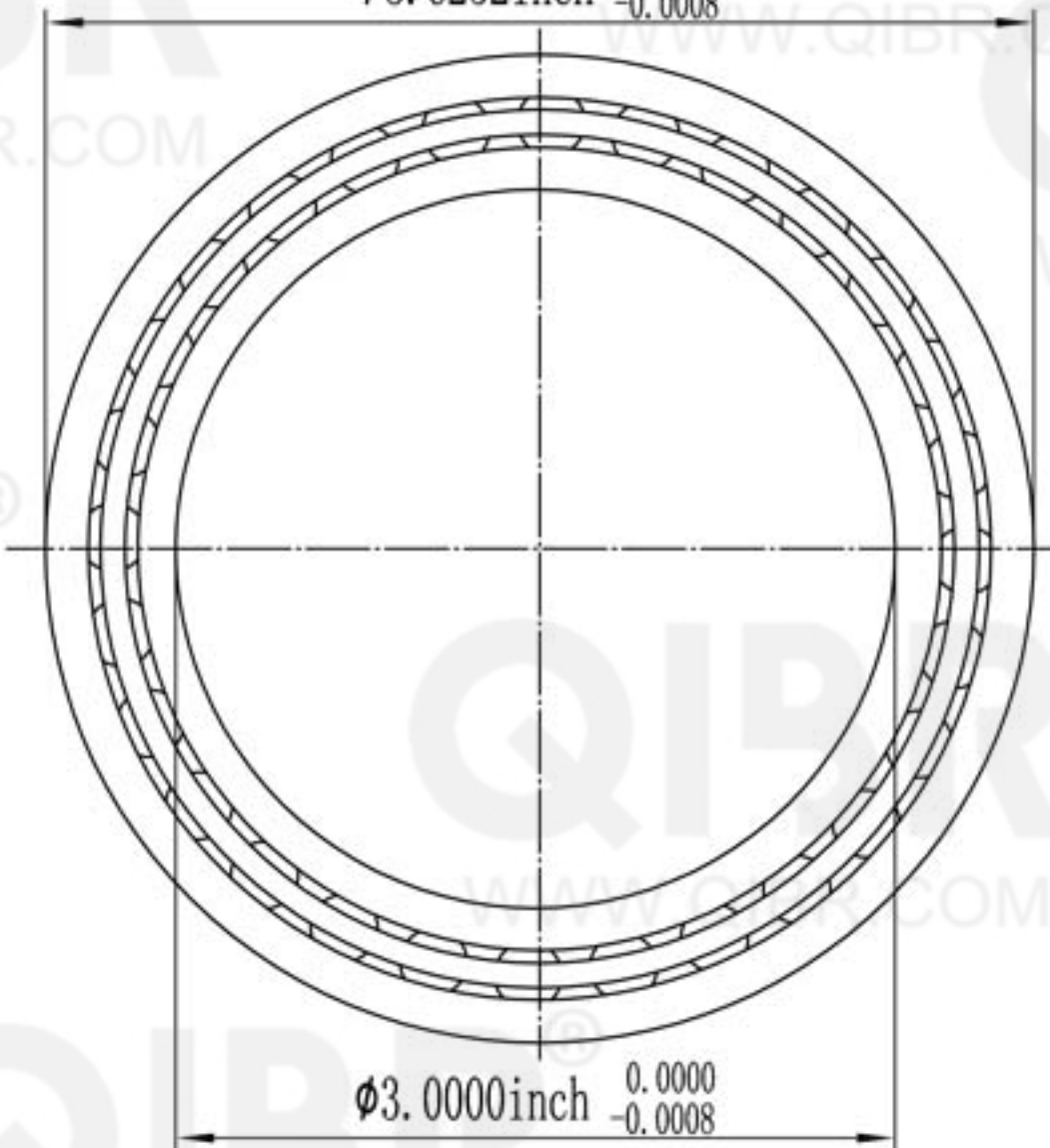

QIBR[®]
BEARINGS

LUOYANG QIBR BEARING CO., LTD

<http://www.QIBR.com>

THIN SECTION
ANGULAR CONTACT
BALL BEARING

PART
NUMBER QNB030ARO