

QIBR®  
WWW.QIBR.COM

QIBR®  
WWW.QIBR.COM



$\phi 280_{-0.035}^0$

$\phi 580_{-0.05}^0$

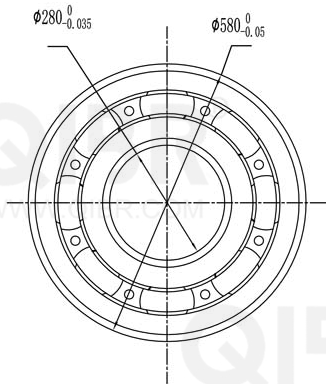

$108_{-0.35}^0$

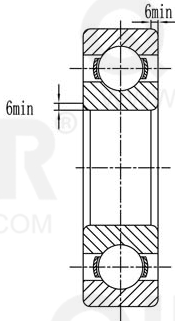

LUOYANG QIBR BEARING CO., LTD  
<http://www.QIBR.com>

Deep Groove Ball Bearing

PART  
NUMBER 6356