

0.375inch $\begin{matrix} +0.000 \\ -0.010 \end{matrix}$

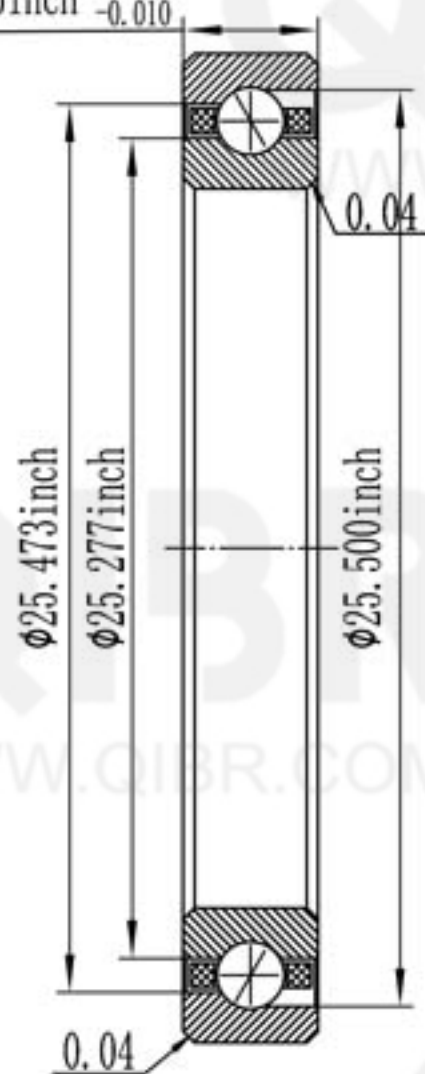

$\phi 25.750$ inch $\begin{matrix} +0.0000 \\ -0.0018 \end{matrix}$

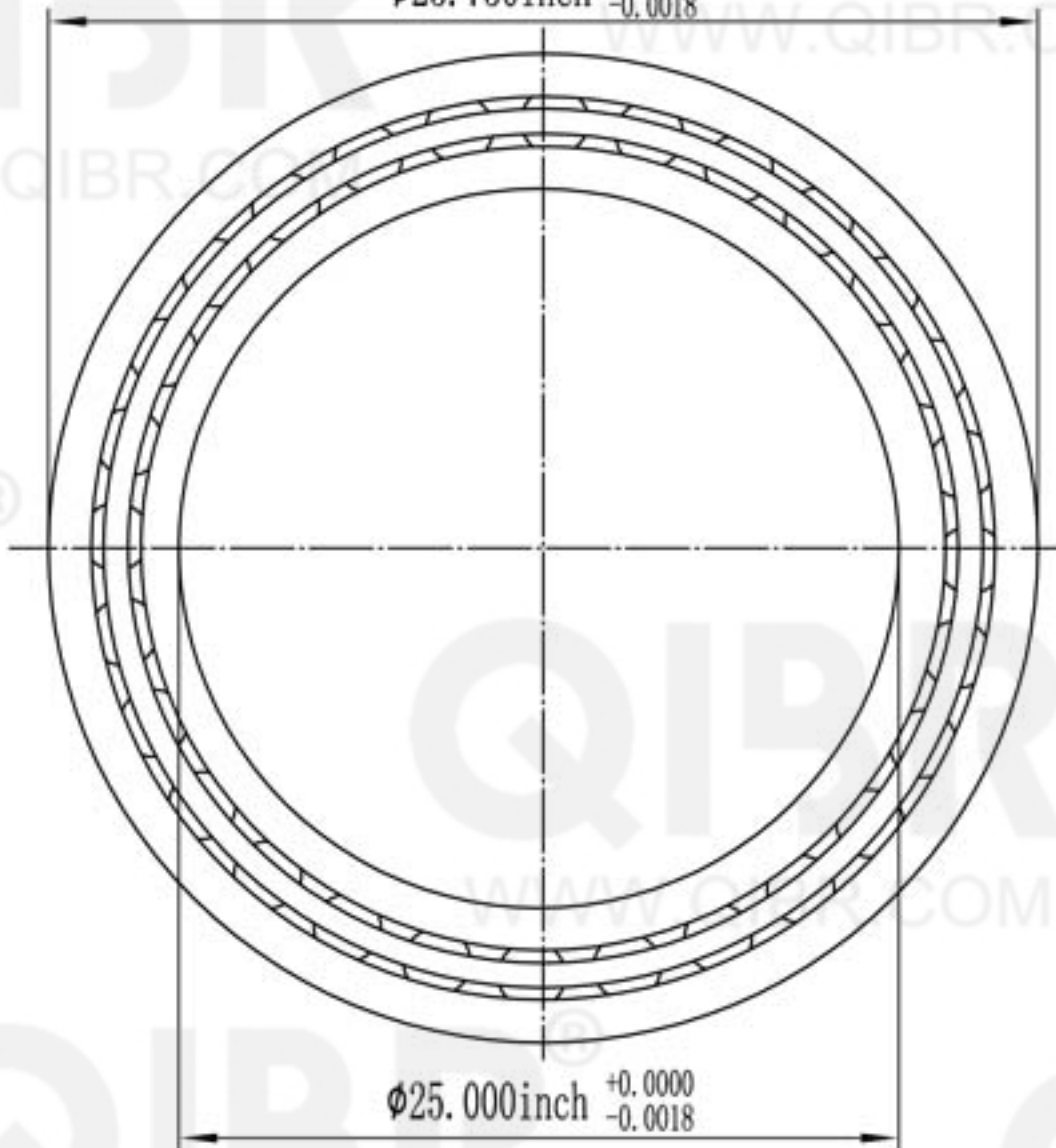

QIBR[®]
BEARINGS

LUOYANG QIBR BEARING CO., LTD

<http://www.QIBR.com>

THIN SECTION
ANGULAR CONTACT
BALL BEARING

PART
NUMBER QSC250ARO