

$\phi 55_{-0.015}^0$

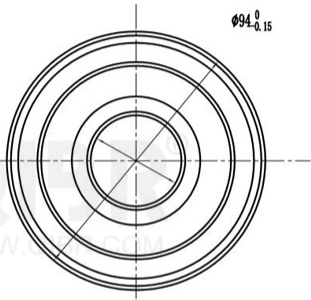

$\phi 94_{-0.15}^0$

27 ± 0.1

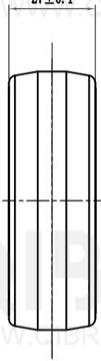

$27_{-0.15}^0$

QIBR[®]
BEARINGS

LUOYANG QIBR BEARING CO., LTD

<http://www.QIBR.com>

Forklift Mast Roller

PART NUMBER

QMR55RR4-94