

$\phi 40_{-0.012}^0$

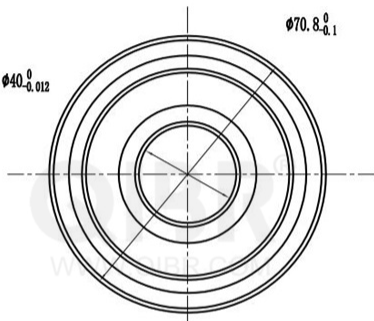

$\phi 70.8_{-0.1}^0$

21 ± 0.1



$18_{-0.12}^0$

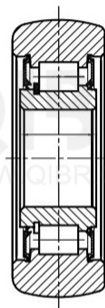

QIBR[®]
BEARINGS

LUOYANG QIBR BEARING CO., LTD

<http://www.QIBR.com>

Forklift Mast Roller

PART NUMBER
QMR40RR2-70